

Chain Drive (Clutch) Operated LuXout® Shade

Smooth, Quiet & Independently Controlled Shade

SUBMITTAL
Technical Info

Please check all appropriate selections and attach room schedule with verified dimensions.

Select Number of Shades Per Unit

- Single Roller (Standard)
- Dual Roller (Supplemental Fabric & Hardware Sheet Required)

Please Note: If you are specifying a Dual Roller Shade, please complete the options BELOW and attach the Chain Drive Dual Roller Fabric and Hardware Planning Sheet.

Select Chain Drive Location

As seen from *INSIDE* the room facing the window.
Also indicate on room schedule.

- Right Side (standard)
- Left Side

Select Fabric Orientation

- Regular Roll (rolls off on window side)
- Reverse Roll (rolls off on room side)



Fabric Wrapped



Exposed Square



Silent Exposed

Select Hembar Style

- Fabric Wrapped
- Exposed Square
- Silent Exposed

Single Roller Motorized Shade Options

Fabric: _____

Color Name / Number: _____

Openness Factor: _____

Please see LuXout's Shade Fabric Reference Guide for fabric colors and specifications.

Select Single Roller Hardware

- Wall
- Ceiling
- Brackets Only
- Fascia Brackets Only
- Brackets w/Fascia
- Endcaps w/Fascia
- Complete Fascia
- Pocket Style Headbox (5x5)
- Hanger
- Closure Panel with Hanger Clip
 - 3" (76mm) Standard
 - 2"
 - 5"

Light Gap Reduction Hardware

- 'L' Angle
- 'U' Channel
- 'H' Channel
- Channel Liners

Select Hardware Finish (does not apply to Pocket Style Headbox)

- Anodized
- Black
- White (Standard and Pocket Style Headbox)
- Bronze
- Custom (Contact LuXout Shades)

AVAILABLE SIZES: Minimum Width = 12"

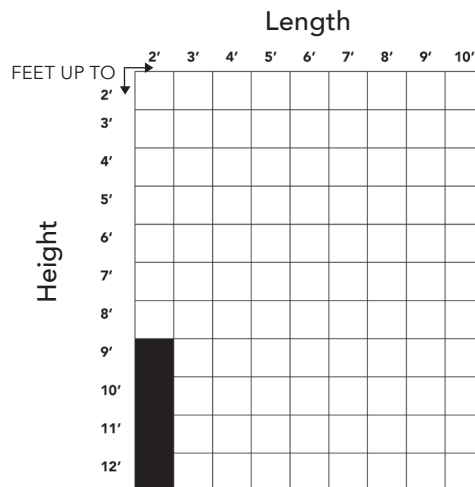

For larger sizes contact LuXout Shades Customer Service



LUXOUT SHADES

1221 Admiral Street
Richmond, VA 23220

LuXoutShades.com
Office: 800.817.1204

PROJECT: _____

SPECIFIER: _____

CONTRACTOR: _____

SUPPLIER: _____

DATE: _____ REVISED: _____

Chain Drive (Clutch) Operated LuXout® Shade Specifications

EQUIPMENT

Chain Drive unit instantly reversible. Lifetime lubrication. Right Hand Standard. Left Hand Available.

HARDWARE

ROLLERS: 1/2" (38mm) and 2" (50mm) extruded aluminum. Roller assembly easily removable.

MOUNTING BRACKETS (42MM): Painted steel stamping. Various sizes depending on mount. Styles for mounting to wall, ceiling, or jamb. Brackets do not require additional adapters.

ROLLER IDLER ASSEMBLY: Injected molded nylon and a cold rolled steel ball bearing pin. Sliding pin for easy installation and removal of the roller.

HEM BAR: Powder coated in black, bronze, white or clear anodized. Oval Half Fabric Wrapped Hem Bar Exposed Square: aluminum with plastic end caps or exposed silent with wall bumper and plastic end caps.

FASCIA: "L" cover of extruded aluminum. Fascia snaps onto end brackets. Clear Anodized, black, white (standard), or bronze powder coat finish available. Continuous fascia available with coupled units.

POCKET HEADBOX: Optional, for pocket installation, includes a "U" shaped back/top/front cover with removable bottom closure flap. LARGE SIZE: 5"x5".

LIGHT GAP REDUCTION HARDWARE: Extruded aluminum. Accepts edges of fabric, prevents light gaps. Interior of channel provides for use of flat head screws. Required exposed silent hem bar.

"L" ANGLE: ¾" x 1" x 12'3" (1.9x2.5x373cm); 1" x 2¾" x 16' (2.5x7x488cm) or cut to length.

"U" CHANNEL: 1" x 2½" x 16' (2.5x76x488cm) or cut to length.

"H" CHANNEL: 1" x 5" x 16' (2.5 x 152 x 488cm) or cut to length.

HARDWARE SELECTIONS

Please Note: Brackets and endcaps have the attachment points for mounting a Chain Drive LuXout Shade.

Wall Mounting Bracket

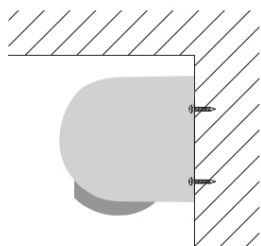

Ceiling Mounting Bracket

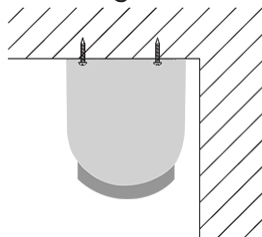

Fascia with Ceiling or Wall Mounting Endcaps

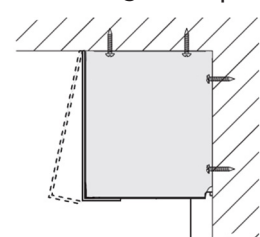

LUXOUT SHADES

1221 Admiral Street
Richmond, VA 23220

LuXoutShades.com
Office: 800.817.1204

PROJECT:	_____
SPECIFIER:	_____
CONTRACTOR:	_____
SUPPLIER:	_____
DATE:	_____
REVISED:	_____

Chain Drive (Clutch) Operated LuXout® Shade Specifications

HARDWARE SELECTIONS (cont.)

Surface Headbox Square Cassette

Consists of:

- Fascia
- Top/Back Cover
- Ceiling/Wall Brackets and Endcaps
- Ceiling/Wall Brackets

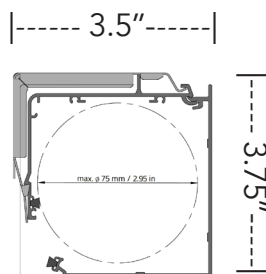

Pocket Style Headbox

Consists of:

- Extruded pocket
- Bottom closure flap
- Ceiling/Wall Endcaps
- Size: 5" x 5"

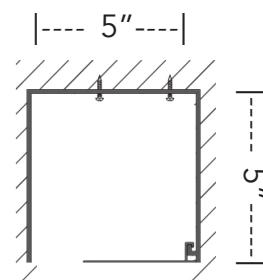

CLOSURE & WALL CLIP OPTIONS

CLOSURE OPTIONS

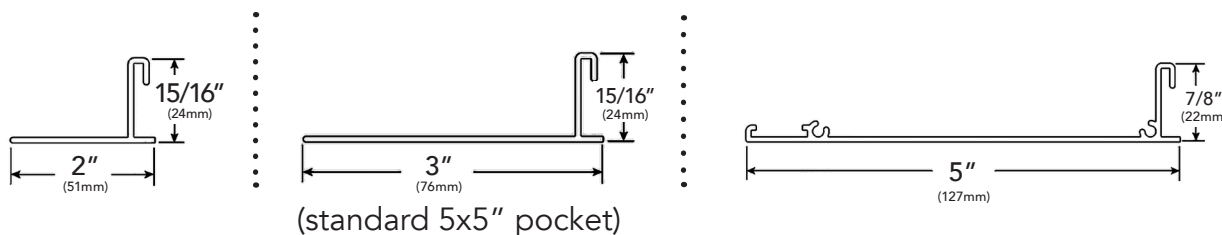

Hanger Details WITHOUT TILE LIP

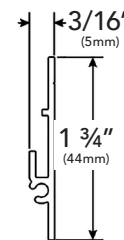

FASCIA ENDCAP COVERS

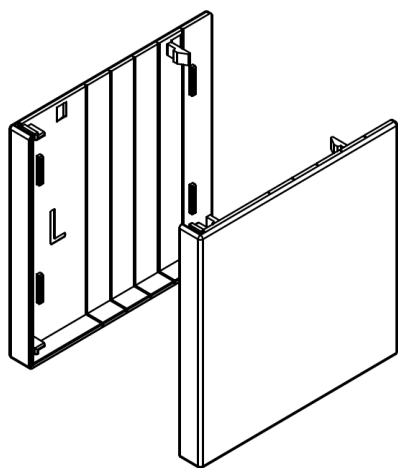

"U" CHANNEL

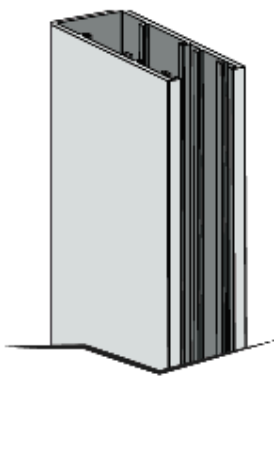

"L" ANGLE

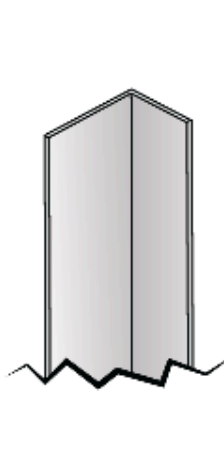

"H" CHANNEL

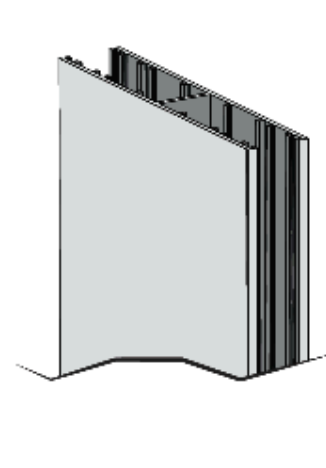

LUXOUT SHADES

1221 Admiral Street
Richmond, VA 23220

LuXoutShades.com
Office: 800.817.1204

PROJECT: _____
 SPECIFIER: _____
 CONTRACTOR: _____
 SUPPLIER: _____
 DATE: _____ REVISED: _____

Chain Drive (Clutch) Operated LuXout® Shade Specifications

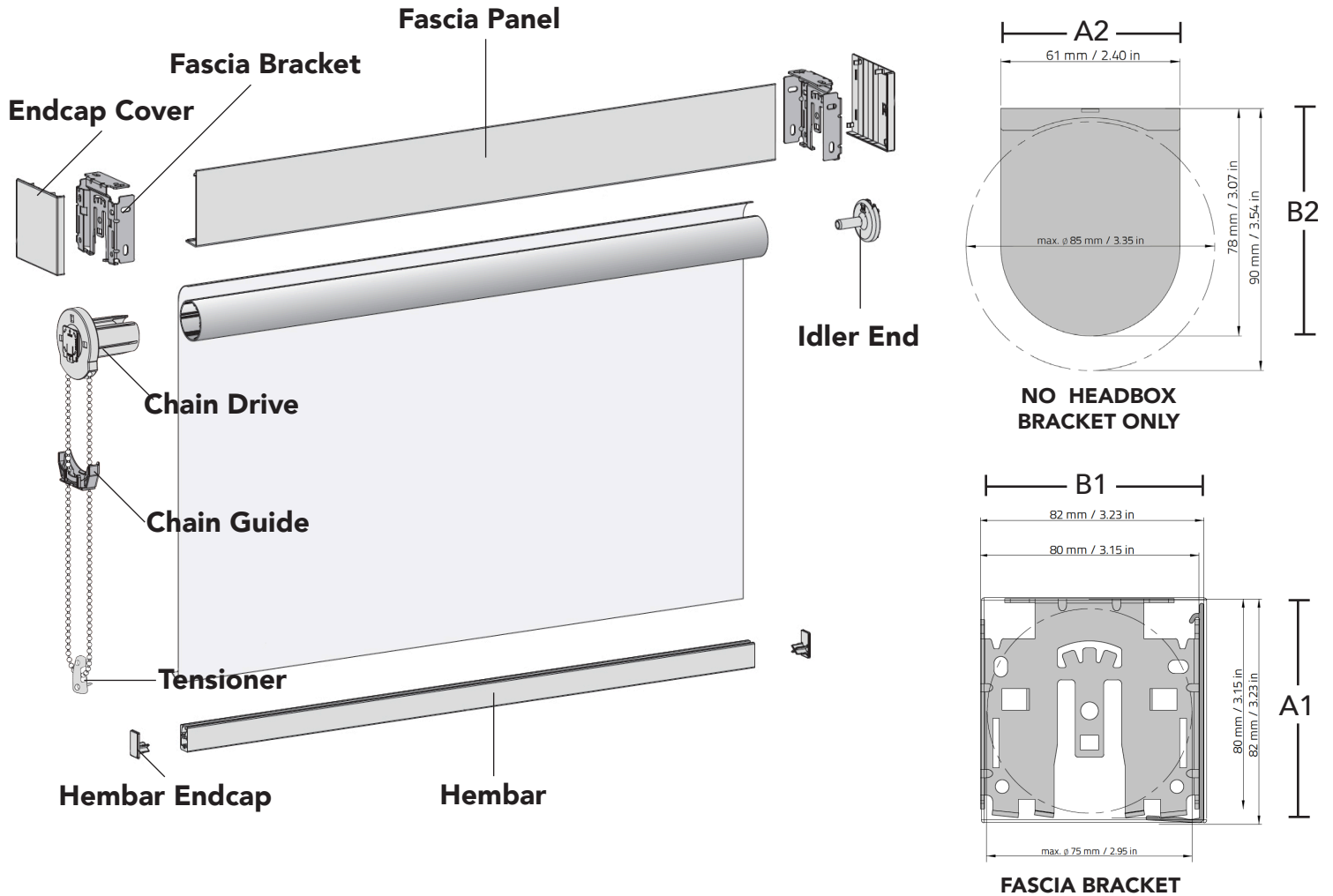

ENDCAPS WITH FASCIA

	SMALL		LARGE	
A1	3"	95mm	5.3"	135mm
B1	3"	76mm	5.3"	135mm

BRACKETS

	STANDARD	
A2	2 3/4"	61mm
B2	2 3/4"	61mm

*All above dimensions based upon 1 1/2" (38mm) diameter roller.



1221 Admiral Street
Richmond, VA 23220

LuXoutShades.com
Office: 800.817.1204

PROJECT: _____
 SPECIFIER: _____
 CONTRACTOR: _____
 SUPPLIER: _____
 DATE: _____ REVISED: _____

Chain Drive (Clutch) Operated LuXout® Shade Fabric & Hardware Planning Sheet

SUBMITTAL
Technical Info

page 5 of 6

Please check all appropriate selections and attach room schedule with verified dimensions. This document is to be used with the LuXout SED Motorized Submittal. On the diagram below, please provide the following information:

If Specifying a Coupled Shade, also indicate desired locations for couplers.

Rear Roller Fabric: _____ Color / Number: _____ Openness Factor: _____
*Please see LuXout's Shade Fabric Reference Guide for fabric colors and specifications.
Front Roller Fabric: _____ Color / Number: _____ Openness Factor: _____
*Please see LuXout's Shade Fabric Reference Guide for fabric colors and specifications.

Please Note: Shade fabrics can be placed anywhere in the headbox. Fabric or screen can be no closer than 13/16" to either end of the headbox.

SELECT DUAL ROLLER HARDWARE

- Dual Endcaps Only**
- Dual Endcaps with Fascia 5.3"x5.3"**
- "L", "U" or "H" Channels for Light Gap Reduction**
 - 'L' Channel
 - 'U' Channel
 - 'H' Channel

(side channels required silent exposed hem bar)

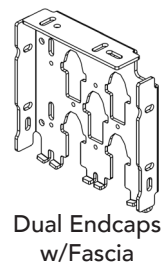
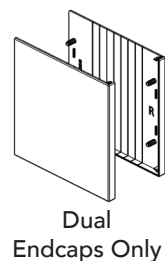

SELECT HARDWARE FINISH

Does not apply to Dual Roller Pocket Headbox

- Clear Anodized
- Black
- White (Standard)
- Custom (Contact LuXout Shades)

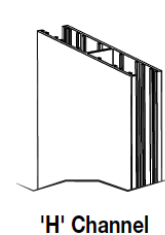
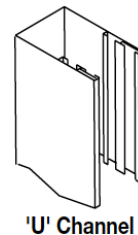
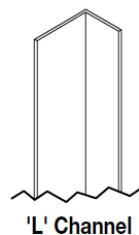

1221 Admiral Street
Richmond, VA 23220

LuXoutShades.com
Office: 800.817.1204

PROJECT: _____
 SPECIFIER: _____
 CONTRACTOR: _____
 SUPPLIER: _____
 DATE: _____ REVISED: _____

Chain Drive (Clutch) Operated LuXout® Shade

Fabric & Hardware Planning Sheet

Dual Roller Chain Drive Operated LuXout Shade Specifications

Two rollers mounted to a single set of endcaps, to accept fascia.

COMPONENTS SPECIFIC TO DUAL ROLLER CHAIN DRIVE OPERATED

DUAL ROLLER ENDCAPS: Steel stamping. Complete with adapter roller bracket. Installs to wall or ceiling. Shades mount in vertical configuration (see drawings). Accepts Dual Roller Fascia.

DUAL FASCIA (FOR ENDCAPS): L-shaped cover of extruded aluminum. Assembly snaps onto endcaps without exposed fasteners. Clear anodized, black, white (standard), or custom powder coat finish available.

CUSTOM DUAL ROLLER POCKET STYLE HEADBOX (not shown):

Headbox of 18 GA Steel, painted white on bottom and front. With or without aluminum ceiling tile lip. Removable aluminum bottom closure attaches without exposed fasteners. Available in stock lengths for installation ahead of shades.

1. Dual Endcap Covers
2. Dual Roller Fascia Bracket
3. Dual Roller Aluminum Fascia Panel
4. Dual Roller Chain Drive
5. Chain Guides
6. Idler End
7. Tensioner
8. Hembar

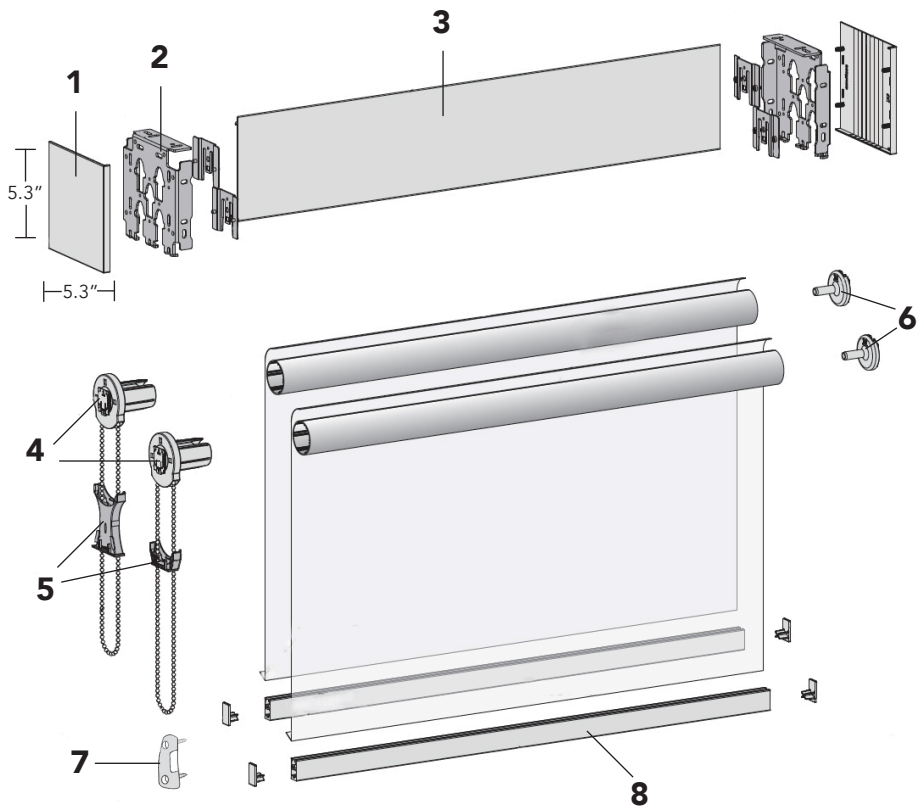

Dual Roller Chain Drive/SED Operated Endcap Dimensions

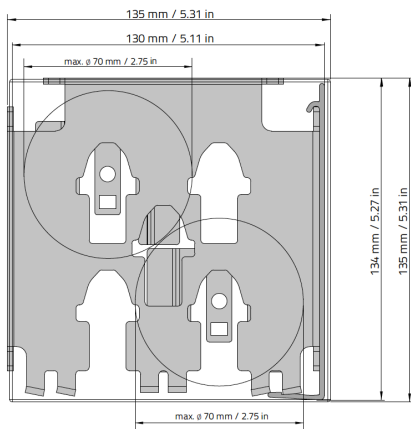

Dual Roller Clutch Operated Endcaps

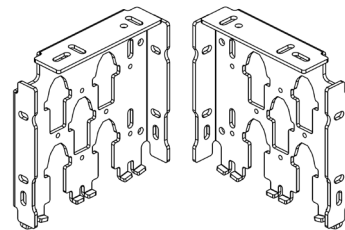

1221 Admiral Street
Richmond, VA 23220

LuXoutShades.com
Office: 800.817.1204

PROJECT: _____
 SPECIFIER: _____
 CONTRACTOR: _____
 SUPPLIER: _____
 DATE: _____ REVISED: _____