

INSTRUCTIONS

DESIGNER ROLLER SHADE - NO HEADBOX

Installation Instructions Designer Roller Shade (No Headbox)

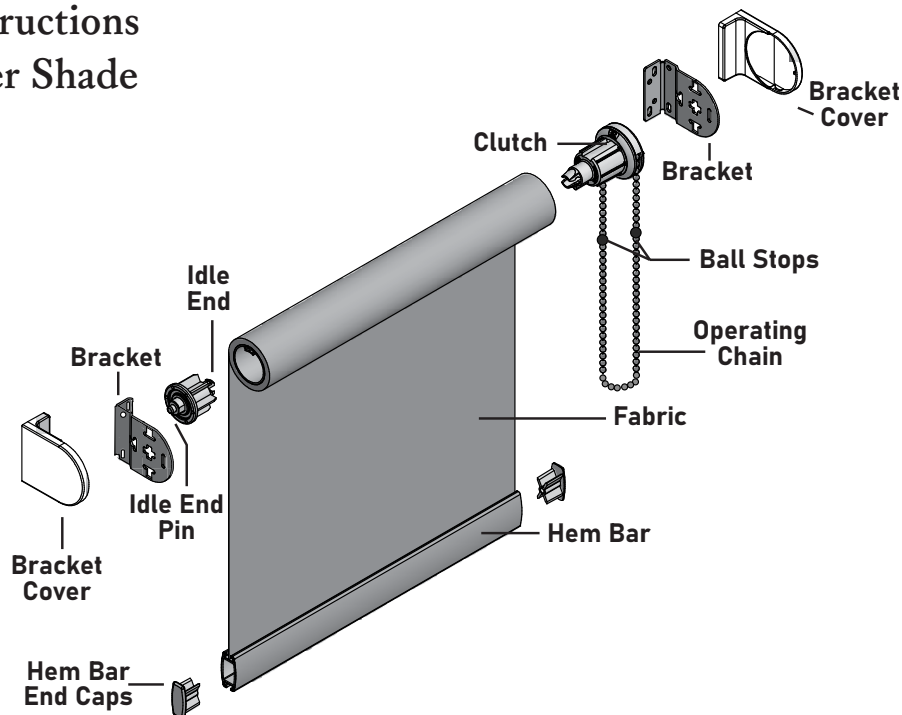

Getting Started

We recommend reading through these instructions before starting the installation. Carefully unpack your shades and check to make sure you have the following installation parts.

Packaged Contents -

- Screws (4)
- Mounting brackets (2)
- Tension device (child safe)
- Bracket covers (2)
- Ball stops (2) (with clutch operated)

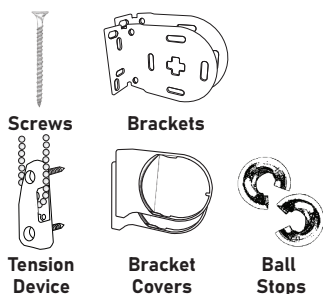

Tools Needed -

- Drill with a 1/8" bit & Phillips head bit
- Phillips screwdriver
- Metal tape measure
- Needle nose pliers
- Level

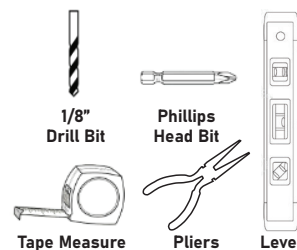

Important Note -

According to the Window Covering Manufacturers Association Inc., all labels must not be removed from the product.

To comply with Child Safety Standards, all tension devices must be installed per the installation instructions provided.

* Please note that your brackets must be securely attached to the mounting surface. If your screws do not hit wood studs you will need to use a different fastener which can be found at any local hardware store.



SPECIFICATION SUBMITTAL

JOB NAME	MODEL NUMBERS		
JOB NUMBER			



INSTRUCTIONS

DESIGNER ROLLER SHADE - NO HEADBOX

1). Determine How You Want to Install Inside (A) or Outside Mount (B)

There are 6 easy ways to install brackets.
Choose which is best suited for your situation.

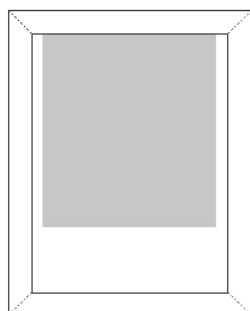

A Inside Mount

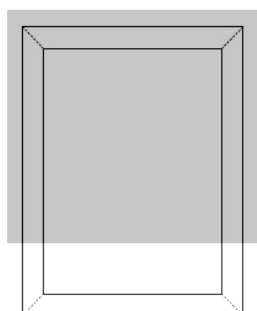

B Outside Mount

Attach the brackets to the window frame, window molding, wall or ceiling, as shown in **Step 3, (frame, outside, or ceiling see below)**. Brackets are universal so control may be mounted on either side. It should be noted however, that the shade is made to be one side or other as ordered.

2). Installing Brackets - Inside Mount

***Slide bracket covers on first before installing.**

Option #1

To mount through side or top of bracket, pre-drill marked indentions using 1/8" bit then install screws to secure.

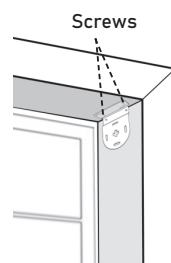

JAMB MOUNT

Option #2

With bracket in place, drill screws into window jamb through pre-drilled holes to secure.

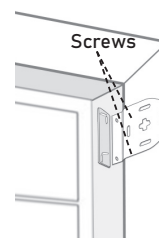

MOUNT

Option #3

For windows that do not have enough depth to install the bracket completely inside the window, position bracket straight on and install screws into side through pre-drilled holes.

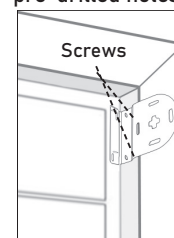

SIDE JAMB

3). Installing Brackets - Outside Mount

- Fit the shade into the brackets and center the shade over the window (this may take two people).
- With a pencil, mark the wall on the side of one bracket. Remove shade and then attach the one bracket with two screws.
- Next, slide the bracket cover over the bracket if needed, then insert the shade into the second bracket. Hold shade up and insert other end into the already mounted bracket making sure that the shade is level.
- Mark the wall on the side of the second bracket. Remove shade, install second bracket with two screws.

With bracket in place, drill screws through pre-drilled holes to secure.

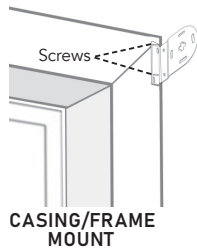

CASING/FRAME MOUNT

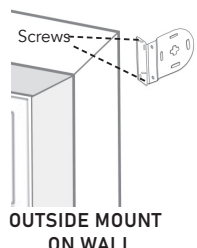

OUTSIDE MOUNT ON WALL

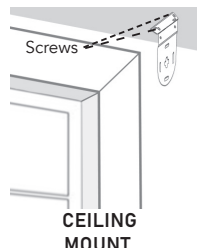

CEILING MOUNT

4). Inserting Shade in Bracket

With the brackets now installed and bracket covers in place, you may install your shade.

Step A).

Put the spring loaded idle end pin into the cross + hole of the bracket. Pushing the pin end towards its bracket, insert the outer hook in the operator side straight into the slots in the opposite bracket.

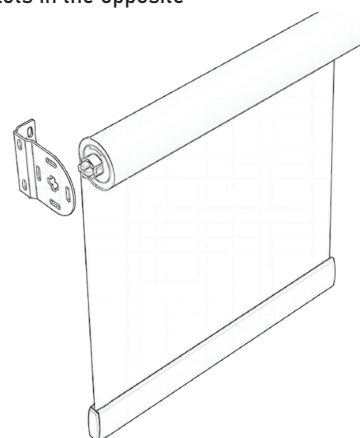

JOB NAME	MODEL NUMBERS		
JOB NUMBER			

INSTRUCTIONS

DESIGNER ROLLER SHADE - NO HEADBOX

4). Inserting Shade in Bracket Cont.

Step B).

Once the center hook is through the slot, gently pull down on the operator until the hook has locked securely to the bracket.

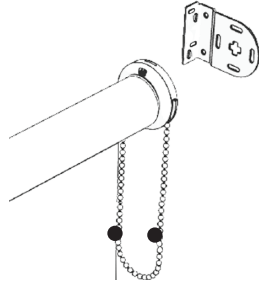

Step C).

Slide bracket covers on mounting brackets.

slide →

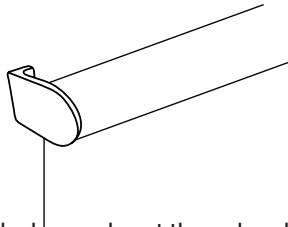
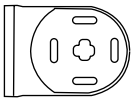

Roller shades are not meant to be lowered past the ordered length. The shade will come with additional fabric that is automatically added in length to conceal the roller tube and to help secure the fabric on the roll.

5). Inserting Shade in Bracket Designer XL Roller Shade Only (Custom Shades Up To 14' wide or very tall)

Insert the Idle End to the bracket and then depress the plunger (when pushed against the bracket plunger it will compress) so it can slide into the Adaptor Plate - then locate this into the cross section of the bracket. Shade should now remain firmly in position. If movements occurs, turn plunger cross end until located into bracket. Confirm the plunger is fixed into position by checking it is fully engaged into bracket.

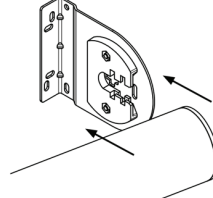

Push the locking body into the bracket adaptor (this will only locate one way). Ensure locking body is fully engaged into adaptor plate.

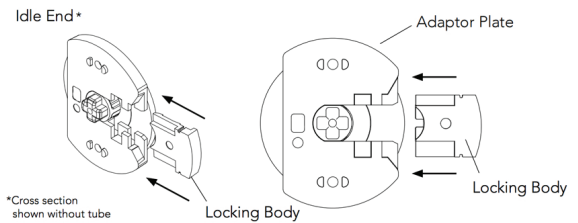

6). Designer XL Roller Shade Only

(Custom Shades Up To 14' wide or very tall) Removal Instructions

First remove the Adaptor Plate Locking Body using a flat head screw driver. Ensure the locking body is completely removed before attempting to remove shade.

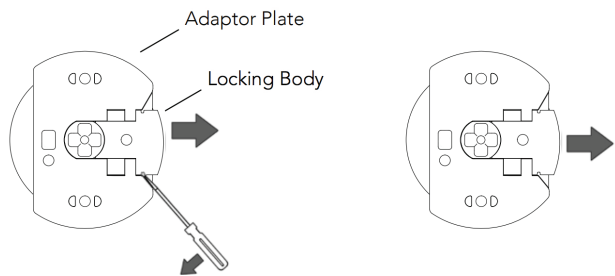

7). Finishing The Install

Installing the Tension Device - Continuous Loop Control

Consider Position of Tension Device

The tension device should be positioned on the window frame or the wall so that the tension device and bead chain do not interfere with operation of window treatment.

- The tension device should be installed so that bead chain is taut without stretching or pulling down on it.
- Stretching the bead chain will cause excessive wear.
- Do not twist or cross the bead chain.

Please DO NOT REMOVE Tension Device or Safety Tag

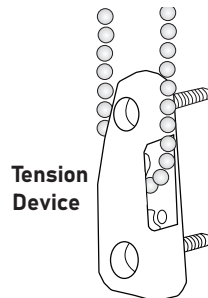

Safety Tag (both sides)



SPECIFICATION SUBMITTAL

JOB NAME	MODEL NUMBERS		
JOB NUMBER			



DESIGNER ROLLER SHADE - NO HEADBOX

8). Finishing the Install Motorized Shade

With the shade now installed...

- Please refer to the separate motor instructions that are specific to your motor.
- Power-up the motor if not a rechargeable battery. Rechargeable battery motors are charged in the factory.
- Pair the motor to the controller.
- Set the upper and lower limits to desired levels if not already set correctly or need adjustment.
- Set up motor shade controls. Each channel has a blue LED light. All shades with an LED light will operate when using the controller.

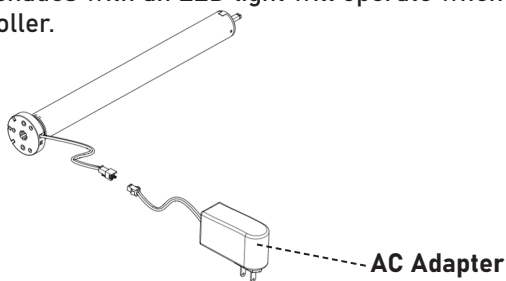

9). Finishing the Install Spring Shade

With the shade now installed, you may use your shade.

NOTE - Initial limits have been set in factory. Use instructions to fine tune.

- Before operating the shade, be sure to first pull out the spring locking pin.
- To test shade operation, tilt the hembar slightly and pull to raise.
- Please refer to the separate spring instructions to adjust spring operation.

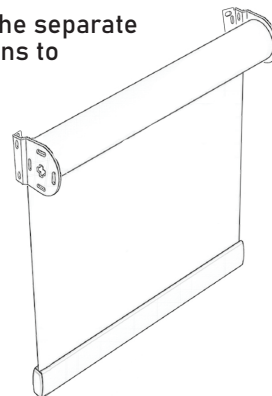

SPECIFICATION SUBMITTAL

JOB NAME	MODEL NUMBERS		
<input type="text"/>	<input type="text"/>	<input type="text"/>	<input type="text"/>
JOB NUMBER	<input type="text"/>	<input type="text"/>	<input type="text"/>